

A Survey on Diagnosis of Diabetic Peripheral Neuropathy

P. Praveen* and Dr. D. Mahesh Kumar**

* Dept. of E&IE, JSSATE, Bengaluru
ppraveen26@gmail.com

** Dept. of E&IE, JSSATE, Bengaluru
dmkjssate@gmail.com

Abstract: Diabetes is the most prevailing metabolic disease and it causes peripheral neuropathy which is a state where the individual loses the sensation of touch and temperature in the peripheral parts of the body like finger tips, toes, etc. Diagnosis of peripheral neuropathy is very important to save a diabetic patient from major injuries and sometimes amputations. Hence, early diagnosis of peripheral neuropathy would help the diabetic patient to be cautious and this would help medical practitioners to administer them with medicines or drugs. This is a survey of such early diagnosis methods which is been researched recently.

Keywords: Type II Diabetes, peripheral neuropathy, early diagnosis, sensation, temperature.

Introduction

Diabetes is the most prevailing metabolic disease. The Indian population is more prone to diabetes nowadays and according to many surveys, India is ranking in top 3 countries with highest populations suffering from diabetes. Type-II diabetes has become too common and can be seen in every 6-7 people out of 10. This is due to insufficient production of insulin or improper utilization of insulin produced due to aging. Other factors which would help to cause type II diabetes are, lifestyle, genetics, obesity, smoking etc.,

The type II diabetic patients often suffer with a state of dysfunction in peripheral neural system. This is a state where the patients lose the sense of touch and temperature in the peripheral parts of the body like finger tips and toes and may spread to the entire organs. This is very hazardous to the diabetic patients because it may lead to cramps, bone degeneration, changes in skin and serious injuries. As these injuries would not get cured in diabetic patients easily, they may turn into decomposition of the injured area and sometimes it may lead to amputations. Hence, such serious problems should be attended with the highest priority. If such cases are diagnosed in the early stages it would help the patient to come out of the issue with aid of proper medications.

The science is so much developed that, many researches have been done in diagnosis of peripheral neuropathy for type II diabetic patients. A few important researches have been listed and discussed here in this paper.

Methodology

In **paper[1]** a low cost non invasive device has been developed to diagnose the diabetic neuropathy in the early stage. This device includes diagnostics of 3 major components in the human body namely, hot and cold temperature perceptions and vibration. Each of the iterations of all the tests yields different resolution, threshold and interval. Heat perception tests and cold perception tests have been provided with heat and cold stimulus respectively. The patient receives the stimulus and



Fig.1

he/she in turn indicates it which is recorded. Similarly vibration stimulus is given to the patient with different amplitude & time periods and the vibration perception is noted. These tests are done on the peripheral parts of the human body in contact with the skin.

A peltier element and a vibrator are used to provide temperature (heat & cold) and vibration stimulation. Along with these, Dallas B-120 Temperature Sensors is used to get the accurate measurement of the temperature as the temperature stimulations given are relative to the environmental temperature. An Arduino Nano and ATmega328 microcontroller is used to control all the electronic circuitry which is linked to the three stimulators, and wireless communication happens through HC-06 Bluetooth module. The block diagram and the diagnostic device of the proposed system are shown below respectively. The readings of the patients are recorded and it is compared with the standard value which is obtained by testing normal subjects. The readings and the graphical representation of the test conducted on a single patient respectively are shown in table 1 and fig.4.

The observations made were:

- a. Deviation in the hot temperature perception test found to be 15-20%.
- b. Deviation in the hot temperature perception test found to be 10-15%.
- c. Deviation in the vibration perception test found to be 3-5 %.

Throughout the project, the safety of the diabetic patients is well maintained. It is a low cost, hazard-free device for early diagnosis of peripheral neuropathy and as it yields the graphical display of results, it is easily readable by the medical practioners.

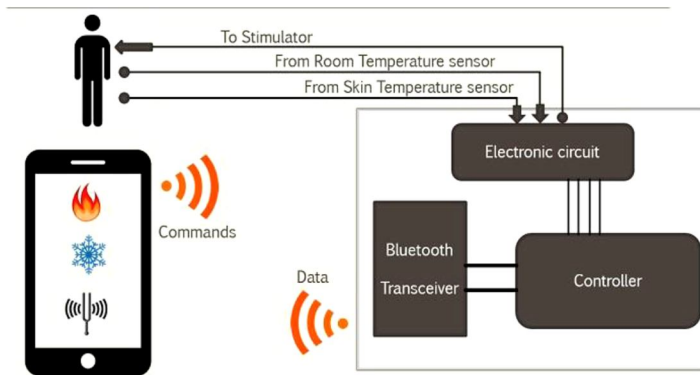

Fig.2

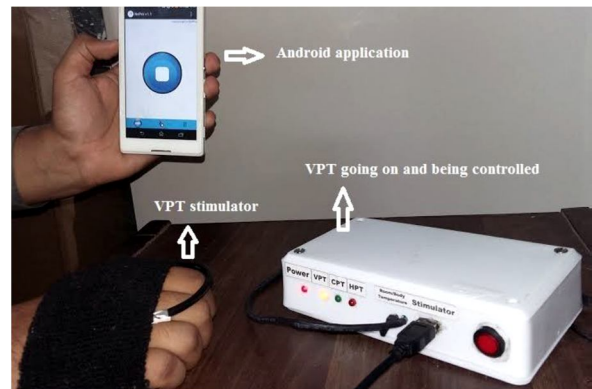

Fig.3

Test type	HPT	CPT	VPT
Units	% Power delivered, differential temperature °C (relative to skin)	% Power delivered, differential temperature °C (relative to skin)	% Power (with rubber damping)
Patient 1	40%, 9°C	35%, -8.2°C	10%
Patient 2	35%, 8.2°C	30%, -6.8°C	8%
Patient 3	40%, 9°C	30%, -6.8°C	9%
Patient 4	30%, 6.8°C	25%, -5.5°C	6%
Patient 5	45%, 10.2°C	35%, -8.2°C	11%
Patient 6	40%, 9°C	35%, -8.2°C	9%
Patient 7	45%, 10.2°C	40%, -9°C	10%
Patient 8	40%, 9°C	30%, -6.8°C	8%

Table 1



Fig.4

In **paper[2]**, a multi sensor platform is made ready for monitoring diabetic peripheral neuropathy. This novel device make uses of ECG and PPG based sensing proposal to monitor the peripheral neuropathy.

Ankle, finger (index-finger/ thumb) is considered as the test area on the human body and dual PPG sensors are placed for measuring the relative change amid the Pulse Arrival Time(PAT). The setup and the PPG signals taken from the ankle and the left thumb are shown in the fig.5 and fig.6 respectively.

Pulse arrival time is normally found out by assessing 1 R-wave of a chest ECG signal to subsequent pulse peak captured on a limb. For accurate measurement of Pulse Arrival Time a stout ECG & PPG peak/valley detection algorithm has been developed using MatLab. The flow chart of the multisensory PAT measurement Technique and the complete experimental setup imposed on the patient is shown in the fig.7 & fig.8 respectively.

This proposed work uses a fixed window based median filter to eliminate the DC components of the the R-wave peaks, and pulse valleys from ECG & PPG signals. Then the actual signal required is obtained by finding the maximum-minimum values within the time window. Then the time delay between an ECG R-wave to the following PG pulse is yielded and in turn Pulse Arrival Time is calculated. The fig.9 shows the PPG signal obtained from the finger and ECG reference signal obtained from chest. The extraction of PPG signals are taken on various parts of the body like knee and ankle, with and without applying the pressure for replicating diabetic peripheral neuropathy. It is shown in the fig.10 and fig.11 respectively.

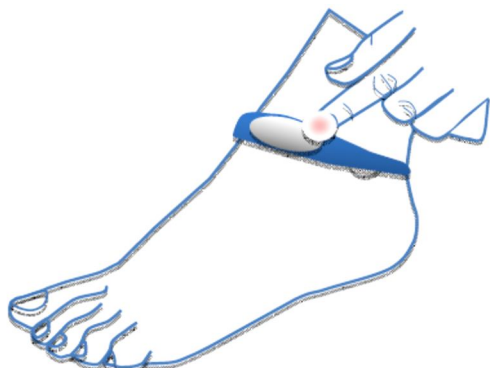

Fig.5

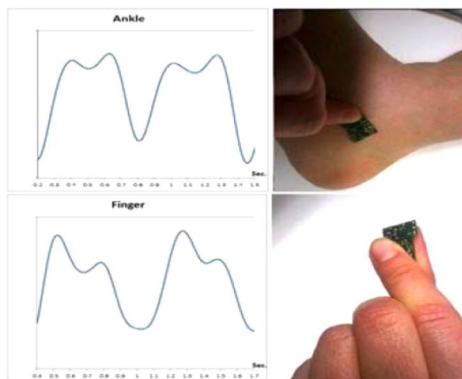

Fig.6

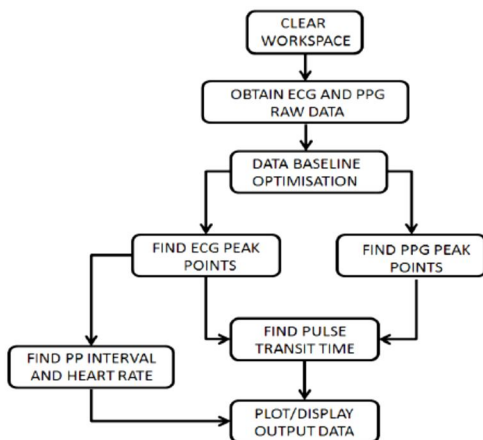

Fig.7

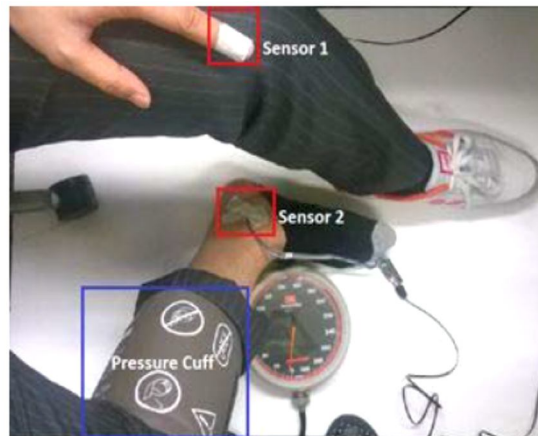

Fig.8

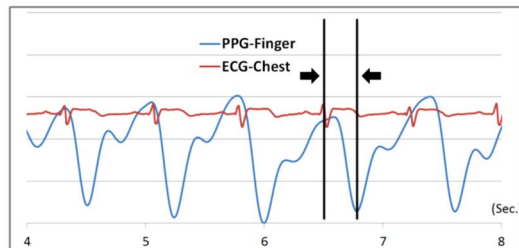

Fig.9

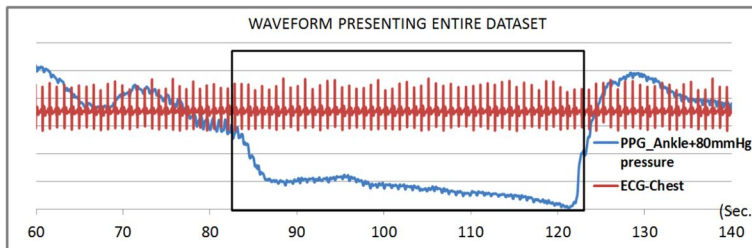

Fig.10

The table 2 shows the pulse arrival time obtained from various sites of the body. This paper has proposed an innovative concept of utilizing multiple PPG & ECG sensors for diagnosing diabetic peripheral neuropathy. By assimilating both the sensors placed at various sites, pulse arrival time is estimated. Early experiments have been conducted to validate the concepts. The arterial stiffness or diabetic peripheral neuropathy is replicated by using a pressure cuff which has yielded a

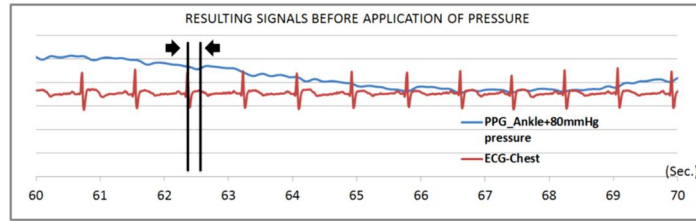

Fig.11

Table 2

SITE	Finger	Ankle, before pressure	Ankle,80mm Hg pressure	Ankle, pressure cuff Released
PULSE ARRIVAL TIME (S)	0.25 ±0.079	0.42 ±0.088	0.92 ±0.11	0.42 ±0.11

positive result in detection of pulse arrival time. This being the first method to diagnose the diabetic peripheral neuropathy using PPG and ECG signals, it is confined to research. Further more studies would make this concept a clinical product.

In paper [3], A thermoregulation model is developed to detect diabetic peripheral neuropathy. Thermoregulation model of the plantar fascia foot is evaluated empirically with the conduction of cold provocation. The thermoregulation model of the foot which is cold provoked is obtained using an IR camera to record temperature. This is experimented on 4 healthy and diabetic peripheral neuropathy subjects. The analysis of the foot is made in 6 major areas namely; Ball1, Ball2, Ball3, Internal Arch, External Arch and Heel. It is as shown in the fig.12. The non-linear thermoregulation model is evaluated in contrast with Newton’s simple cooling model and this has yielded better results. Blood flow decreases via cutaneous vasoconstriction when exposed to cold. Gradually heat dissipation from the surface of the skin and convective transfer of heat gets altered from the surface of the foot.

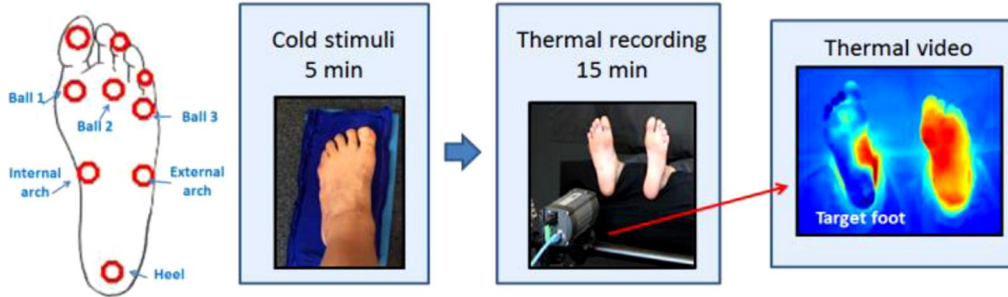

Fig.12

Fig.13

The vasoconstrictor system is accountable for the reduction in the skin blood flow which usually occurs when the foot is rendered to cold. This is used as a biomarker when such changes appear in the diabetic peripheral neuropathy patients. Using thermal imagery process, the homeostasis process is recorded once the foot is removed from cold provocation. This thermoregulation model would yield changes in the thermoregulation model of the diabetic peripheral neuropathy patients. The experimental steps are as shown in the fig.13. The subject’s feet is cold provoked and later subjected to the IR camera for imagery. The image of the foot which is having more blue area is the target foot which is subjected to cold provocation. The eight subjects underwent this test out of which 4 were healthy and the other 4 were diabetic patients.

Due to diffusion, blood perfusion, and metabolic heat generation, surface tissue temperature gets changed and it is modeled using the Pennes’ Bio-Heat equation, where T_0 is the initial temperature and k is the constant and a function of the material (tissue).

$$T(t) = T_A + (T_0 - T_A)e^{-kt}, \text{ where } T_A = \frac{r_b T_b + r_e T_e}{r_b + r_e}$$

It is the observation made that, the substantial, essentially exponential initial thermal recovery rate occurs from the empirical data. Fitting error of Newton’s and proposed model used to find the root mean square error for the data represented in the fig.14. It is observed that in the first two minutes, the error of Newton’s model is 5x times the error as proposed in the paper. The RMSE for each of the region of interest of both models are computed and evaluated as shown in table 3. The box plots

for the DPN and healthy subject using parameters the intensity of regulation (Q) and speed of regulation (s) of the proposed system is shown in the fig.15.

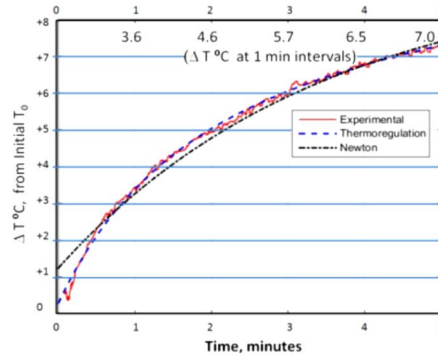

Fig.14 Comparison of thermoregulation data and Newton’s model

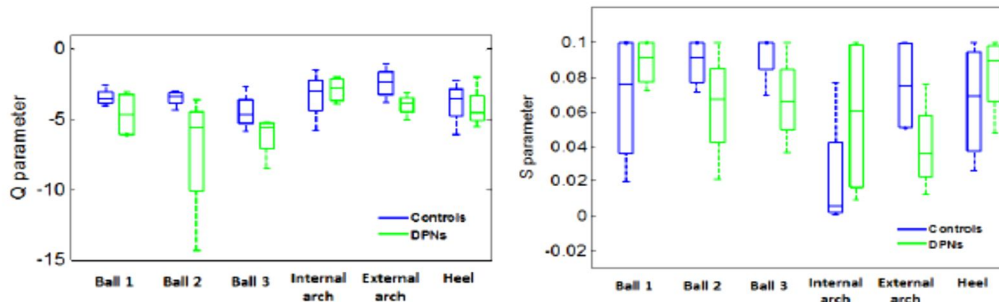

Fig. 15

Table 3

ROI #	RMSE					
	0 to 1 min		5 to 10 min		0 to 10 min	
	Newton	Proposed	Newton	Proposed	Newton	Proposed
1	16.1	2.6	0.9	0.9	5	1.1
2	12.8	2.2	1.5	1.5	4.6	1.0
3	18	2.3	1.4	1.4	5.6	1.1
4	3.1	1.8	0.9	0.9	1.9	0.8
5	6.1	2.1	0.8	0.8	3.2	0.9
6	4.9	2.3	0.8	0.8	4.7	1.0

Table 4

Features	AUC	Features	AUC
Q – ROI 1	0.63	s – ROI 1	0.63
Q – ROI 2	0.94	s – ROI 2	0.75
Q – ROI 3	0.81	s – ROI 3	0.81
Q – ROI 4	0.5	s – ROI 4	0.88
Q – ROI 5	0.94	s – ROI 5	0.88
Q – ROI 6	0.56	s – ROI 6	0.62
max(Q2, Q3, Q5))	1.00	max(s2,s3,s4,s5)	0.75
min(Q2, Q3, Q5))	0.94	min(s2,s3,s4,s5)	0.81

From the results obtained, it is observed that most of the thermoregulation has occurred in the first minute. When compared to other models, it is normally found that this significant first minute is ignored and the recordings are made for the rest of the time. The errors obtained with Newton’s law are found to be 1.7 to 7.8 times the error of the proposed model. Considering the ball2 region in fig.15, it can be observed that, the Q values seem to be more negative than the S values. This designates that the model can easily set apart the healthy and DPN subjects. The table 4 gives the Q & S parameter- performance results.

Conclusion

The paper [1] is a low cost, hazard-free device for early diagnosis of peripheral neuropathy which yields the graphical display of results. The more number of subjects should be experimented on to make it applicable to clinical usage.

The paper [2] has proposed an innovative concept of utilizing multiple PPG & ECG sensors for diagnosing diabetic peripheral neuropathy. Making a subject to wear PPG and ECG sensors seems to be a cumbersome process. Assimilation of both the sensors placed at various sites yields pulse arrival time. Simulating DPN and finding PAT seems to be innovative. This being the first method to diagnose the diabetic peripheral neuropathy using PPG and ECG signals, it is confined to research. Further more studies would make this concept a clinical product.

The paper [3] has proposed a thermoregulation model to assess the DPN. This is an affirmative model where the thermoregulation model which is obtained and observed gives in a positive result compared to other distinct models.

References

- [1] A Low-Cost, Non-Invasive Sensory Device for Early Diagnosis of Diabetic Peripheral Neuropathy by Mubariz Zaffar, Muhammad Taihami Tariq, Muhammad Alp Arsalan, Nauman.K.Qureshi and Hammad M. Cheema: 978-1-5090-2455-1/16/\$31.00 ©2016 IEEE
- [2] A Multi-Sensor Platform for Monitoring Diabetic Peripheral Neuropathy by Ching-Mei Chen, Kosy Onyenso, Guang-Zhong Yang and Benny Lo, The Hamlyn Centre, Institute of Global Health Innovation, Imperial College London: 978-1-4673-7201-5/15/\$31.00 ©2015 IEEE
- [3] A thermoregulation model to detect diabetic peripheral Neuropathy by Carla Agurto¹, Viktor Chek², Ana Edwards¹, Zyden Jarry¹, Simon Barriga¹, Janet Simon³, Peter Soliz¹; 978-1-4673-9919-7/16/\$31.00 ©2016 IEEE
- [4] Diabetes atlas, International Diabetes Federation, Version 2015 UK
- [5] D. S. Sims Jr., P. R. Cavanagh, and J. S. Ulbrecht, "Risk factors in the diabetic foot: recognition and management," *Physical Therapy*, vol. 68, no. 12, pp. 1887–1902, 1988.
- [6] K. Roback, "An overview of temperature monitoring devices for early detection of diabetic foot disorders," *Expert Review of Medical Devices*, vol. 7, no. 5, pp. 711–718, 2010.
- [7] Boulton A. Management of diabetic peripheral neuropathy. *Clinical Diabetes* 2005;23:9–15.
- [8] Using thermal perception evaluation of a simple outpatient procedure Early recognition of diabetic neuropathy: V Viswanathan, C Snehalatha, R Seena and A Ramachandran.
- [9] J. M. Torpy, J. L. Kincaid, and R. M. Glass, "Peripheral Neuropathy," *Jama-journal of The American Medical Association*, vol. 303, pp. 1556-1556, 2010
- [10] J. Dros, A. Wewerinke, P. J. Bindels, and H. C. van Weert, "Accuracy of Monofilament Testing to Diagnose Peripheral Neuropathy: A Systematic Review," *Annals of Family Medicine*, vol. 7, pp. 555-558, 2009
- [11] A. J. Boulton, "Management of diabetic peripheral neuropathy," *Clinical diabetes*, vol. 23, pp. 9-15, 2005
- [12] W. Chan, I. A. MacFarlane, D. Bowsher, and J. A. Campbell, "Weighted needle pinprick sensory thresholds: a simple test of sensory function in diabetic peripheral neuropathy," *Journal of Neurology, Neurosurgery, and Psychiatry*, vol. 55, pp. 56-59, 1992.
- [13] G.J. Hodges, J.A. Traeger, T. Tang, W.A. Koshiba, K. Zhao, J.M. Johnson, "Role of sensory nerves in the cutaneous vasoconstrictor response to local cooling in humans," *Am J Physiol Heart Circ Physiology*, vol. 293, pp. 784- 789, 2007.
- [14] M. Burge, G. Zamora, E. S. Barriga, V. Chekh, S. Luan, P. Heintz, A. Edwards, E. McGrew and P. Soliz "Thermal Functional Imaging for Screening of Peripheral Neuropathy in the Diabetic Foot," American Diabetes Association, 72nd Scientific Session, Philadelphia, PA, 2012.
- [15] S Bagavathiappan, J Philip, T Jayakumar, B Raj, PNS Rao, M Varalakshmi, and V Mohan, "Correlation between plantar foot temperature and diabetic neuropathy: A case study by using an infrared thermal imaging technique," *Journal of Diabetes Science and Technology*, vol. 4, no. 6, pp.1388- , 2010.